

AMPFIBIAN RV-PLUS Weatherproof 15A to 10A Power Adaptor with RCD and MCB

Mfg.# 68714

No. DESCRIPTION

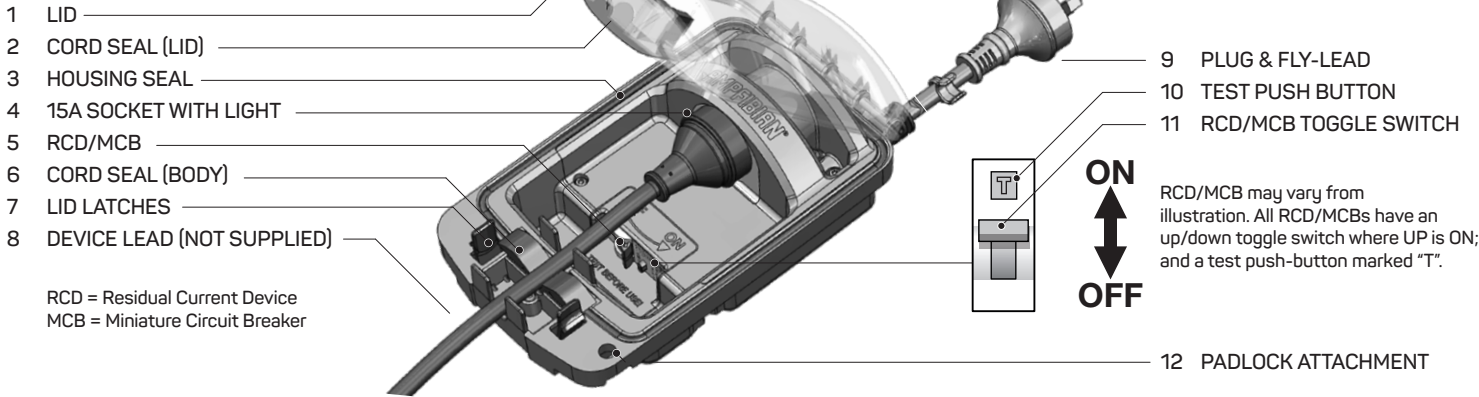

RCD = Residual Current Device
MCB = Miniature Circuit Breaker

USING THE AMPFIBIAN RV-PLUS

1. With nothing plugged in, connect the RV-PLUS's plug (9) directly into power supply (wall) socket and switch power supply ON.
2. Switch RV-PLUS ON (11). If unit trips, unplug it and contact us. **DO NOT USE** or continue to next step.
3. Press test button labelled "T" (10). If switch (11) trips OFF continue to step 4. If switch (11) **DOES NOT** trip when test button pressed, unplug RV-PLUS and contact place of purchase. **DO NOT** use RV-PLUS or continue to step 4.
4. Connect device lead (8) to RV-PLUS socket. Avoid any strain on the lead.
5. Connect RV-PLUS lead (8) to operating device (caravan, RV, etc.).
6. Switch RV-PLUS to ON position (11).

Lid (1) must be latched closed before use. Ensure both latches are fully engaged. Inspect seals (2,3,6) for damage and/or obstruction. Do not use if lid, seals or latches (7) are damaged or inoperable.

IF RV-PLUS TRIPS IN SERVICE

First rule out that the RV-PLUS is at fault by performing the above test procedure. The RV-PLUS will trip due to overload or an earth leakage fault. If you are unsure of the cause, or you believe there is an earth

leakage fault, turn off all power and contact a licensed electrician. If you believe there is an overload, switch off or unplug some of the appliances and reset the RV-PLUS.

Electricity can be dangerous! RCDs (Residual Current Devices) are not a substitute for basic electrical safety precautions. RCDs are additional protection and will not prevent shock, but will minimise the effect. Do not use this device if it fails to operate correctly in accordance with these instructions.

The RV-PLUS is rated 240 Volts with a maximum current rating of 10 Amperes (A).

Do not try to open or repair the RV-PLUS yourself. No user-serviceable parts are inside. Test RV-PLUS before each use as described in step 3. This device will only protect against faults to earth through the body, but not against active to neutral faults.

This device must be connected **DIRECTLY** to an outlet socket. It must not be connected via cord extension sets.

Wet seals will freeze and will not recover their shape until thawed. Do not open frozen unit until thawed. Opening frozen unit may result in damage to seals.

Do not expose to petrol, oil, solvents, pool chemicals, etc.!

Do not use in hazardous locations!

Do not use if damaged!

Do not disassemble!

Ingress protected to IP55.

Do not drop or immerse in water!

Remove condensation / moisture with a soft absorbent cloth.

Only connect to power if unit is completely dry inside.

Turn off power supply before handling connections in wet conditions!

Store in a dry place out of direct sunlight.

Ensure there is no gap visible through cord seals when closed! If required, leave lid open until cord seals have fully recovered.

This product is not intended for permanent installation. Do not bury!

Suitable for ordinary and heavy-duty extension leads to 12mm diameter.

To be used with 10A (2400W) maximum load.

LIMITED WARRANTY

Every Ampfibian product is thoroughly inspected and tested before leaving our factory. Ampfibian Pty. Ltd. limits this warranty against defective workmanship and faulty materials under normal use for twentyfour (24) months from date of purchase (proof of date of purchase must be provided) and undertakes at its option to repair or replace each product or part thereof on condition that:

- The product has not been subject to misuse, neglect, accidents or alterations;
- The unit has been used and maintained as per the instructions.

Ampfibian Pty. Ltd. is not liable for any consequential damage to either people, work or facilities from using the Ampfibian.

Please ensure Ampfibian is actually faulty before returning it, by testing it on a different power circuit and with a different appliance. Please see the "Return & Refund Policy" page on our website or contact us for details. All shipping costs are the responsibility of the customer.

Please staple your purchase receipt (or a copy) to this document. You will be asked to provide a filled-out copy of this form and proof-of-purchase in the event of a warranty claim.



If you want an extra year's cover free (three in total), register your warranty online at ampfibian.com.au



DATE OF PURCHASE: _____

PURCHASED FROM: _____

PURCHASER'S NAME: _____

CONTACT INFORMATION: _____

Please keep these instructions with you. *Only send this form to Ampfibian in case of a warranty claim!*

RATING KEY

Ingress Rating		Impact Rating
SOLID	LIQUID	
IP1_	IP_1	IK04
Protection of the back of the hand against accidental access to hazardous parts and objects larger than 50mm	Protection against vertically falling water drops	0.5 Joules Impact Energy Drop of 200g object from a height of 250mm
IP2_	IP_2	IK05
Protection of fingers against access to hazardous parts and objects larger than 12.5mm	Protection against vertically falling water drops up to 15° from vertical	0.7 Joules Impact Energy Drop of 200g object from a height of 350mm
IP3_	IP_3	IK06
Protection of persons holding tools or wires larger than 2.5mm diameter	Protection against spraying water (rain) at an angle up to 60° from vertical	1.0 Joules Impact Energy Drop of 500g object from a height of 200mm
IP4_	IP_4	IK07
Protection of persons holding tools or wires larger than 1mm diameter	Protection against splashing water from any direction (360°)	2.0 Joules Impact Energy Drop of 500g object from a height of 400mm
IP5_	IP_5	IK08
Protection against entry of dust in sufficient quantity to interfere with equipment	Protection against water jets from any direction (360°)	5.0 Joules Impact Energy Drop of 1700g object from a height of 295mm

HOW AMPFIBIANS PROTECT YOU



FIRE



SHOCK



LOSS

Cause:

Overload
DEATH-LEAD

Cause:

Short Circuit
Bad/old/damaged wiring

Cause:

Spike
Generators, lightning

Protection:

Breaker
Fuse or M.C.B.
Miniature Circuit Breaker

Protection:

R.C.D.
Residual Current Device

Protection:

Surge Protector

Higher "Joule" rating gives better protection

Combined into a single "R.C.B.O."
(Residual-Current-Breaker-Overload)





10A PLUG



15A SOCKET

MINI







10A PLUG



15A SOCKET

RV-PLUS







10A PLUG



15A SOCKET

MAX





15A PLUG





15A SOCKET





CARAVAN SURGE PROTECTOR

15A Caravan Surge Protectors (work with Adaptors)

15A to 10A Power Adaptors with RCD and MCB

All caravan electrical supply equipment must be weatherproof to at least IP44











Operating Environment	
L-Class	H-Class
A single phase portable RCD primarily intended for household use	A portable RCD intended for general industrial use
	

Electrical Protection	
 RCD 	 MCB 
Residual Current Device: Immediately cuts the power if a difference between incoming and outgoing voltage is detected. Protects people against the effects of electrocution	Miniature Circuit Breaker: Cuts the power in case of overload. Protects circuits from overheating and catching fire

PLEASE NOTE:
This unit contains country specific components and must be used in its country of purchase:
- AU has a C-type RCBO
- NZ an FS A-type RCBO



ADAPTOR RANGE

PRODUCT	MINI-BLUE	MINI-BLACK	MINI	RV-PLUS	MAX
COUNTRY	NZ	NZ	ANZ	AUSTRALIA	ANZ
STANDARDS COMPLIANCE	AS/NZS3001	AS/NZS3001 AS/NZS3190	AS/NZS3001	AS/NZS3001 AS/NZS3190	AS/NZS3001 AS/NZS3190
DEVICE CLASS	L-CLASS	H-CLASS	L-CLASS	L-CLASS	H-CLASS
IMPACT RATING	IK08	IK08	IK08	IK08	IK08
LOAD SOCKET	16A CEE 	16A CEE 	15A 	15A 	15A 
WEATHERPROOFING	IP33	IP44	IP33	IP55	IP55
MAX. LOAD	2400W	2400W	2400W	2400W	2400W
MAX SUPPLY	10A	10A	10A	10A	10A
SUPPLY LEAD PLUG					





**PC/POM/
PVC parts**



1791-INSTRUCT-PLUS-D